

Beam clamp model YC

Capacity 1000 - 10000 kg

Provides a quick and versatile rigging point for hoisting equipment, pulley blocks or loads. Flexible application due to wide adjustment range. The central threaded spindle allows easy attachment and a safe and secure grip. The spindle can be secured against loosening.



INFO

Yale hoists and trolleys are not designed for passenger elevation applications and must not be used for this purpose.

Technical data model YC

Model	EAN-No. 4025092*	Capacity kg	Beam flange width mm	Weight kg
YC 1	*055154	1000	75 - 230	3.8
YC 2	*055161	2000	75 - 230	4.6
YC 3	*055192	3000	80 - 320	9.2
YC 5	*055208	5000	90 - 320	11.0
YC 10	*055215	10000	90 - 320	17.2

Dimensions model YC

Model	YC 1	YC 2	YC 3	YC 5	YC 10
A min., mm	115	115	180	180	175
A max., mm	150	150	225	225	220
A1, mm	78	78	80	90	90
A2, mm	246	246	320	310	320
B1, mm	186	186	232	242	268
B2, mm	350	350	455	445	480
b1, mm	75	75	80	90	90
b2, mm	230	230	320	310	320
C, mm	50	50	70	70	70
D, mm	4	6	8	10	14
E, mm	215	215	255	255	275
F1, mm	34	35	35	35	35
F2, mm	17	18	21	21	20
G1, mm	82	82	120	116	110
G2, mm	44	44	75	75	66
H, mm	20	20	22	28	38
J1, mm	14	14	30	30	34
J2, mm	21	21	34	34	35
K1, mm	48	50	60	60	60
K2, mm	31	32	40	42	40
L, mm	84	94	122	129	146

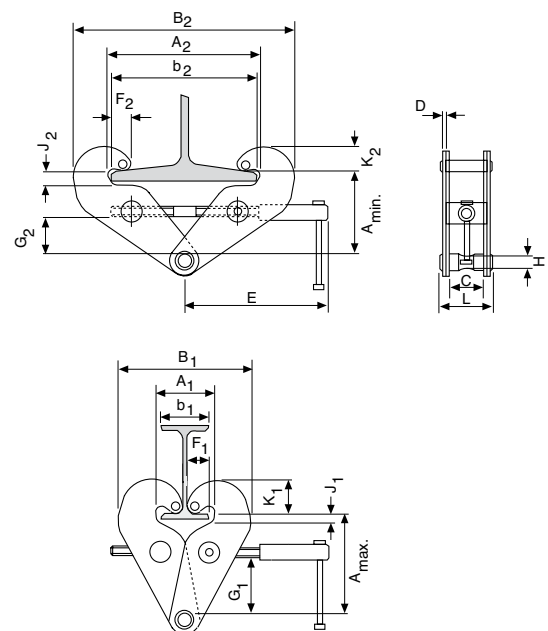



Push and geared type trolley model HTP and model HTG

Capacity 500 - 20000 kg

The trolley enables the exact positioning or easy traversing of large loads with either manual or powered hoisting equipment.

Features

- It has excellent rolling features due to machined steel wheels mounted on prelubricated, encapsulated ball bearings.
- Adjustable to fit a wide range of beam widths and profiles (e.g. INP, IPE and IPB).
- Adjustments are made by rotating the clevis load bar which also ensures the centred positioning of the hoist in the clevis – no creeping to the left or the right.
- The trolley wheels are designed for a max. beam profile incline of 14% (DIN 1025 - part 1).

Options

- Rotating hand chain guide.
- Stainless steel hand chains.
- Buffers
- Corrosion resistant version.
- Locking device to secure the trolley in position on the beam (park position e.g. on ships).

INFO

Yale hoists and trolleys are not designed for passenger elevation applications and must not be used for this purpose.

Technical data model HTP

Model	EAN-No. 4025092*	Capacity kg	Size	Beam flange width b mm	Beam flange thickness t max. mm	Curve radius min. m	Hand effort at WLL daN	Weight kg	Weight with locking device kg
HTP 500	*054874	500	A	50 - 220	25	0.9	-	8.0	14.5
HTP 1000	*054881	1000	A	50 - 220	25	0.9	-	9.0	17.0
HTP 2000	*054898	2000	A	66 - 220	25	1.15	-	16.0	24.0
HTP 3000	*054904	3000	A	74 - 220	25	1.4	-	32.0	41.2
HTP 5000	*054911	5000	A	90 - 220	25	1.8	-	48.0	58.5
HTP 500	*054928	500	B	160 - 300	40	0.9	-	10.6	17.1
HTP 1000	*054935	1000	B	160 - 300	40	0.9	-	12.0	20.0
HTP 2000	*054942	2000	B	160 - 300	40	1.15	-	19.3	27.3
HTP 3000	*054959	3000	B	160 - 300	40	1.4	-	35.8	45.0
HTP 5000	*054966	5000	B	180 - 300	40	1.8	-	52.2	62.7

Technical data model HTG

Model	EAN-No. 4025092*	Capacity kg	Size	Beam flange width b mm	Beam flange thickness t max. mm	Curve radius min. m	Hand effort at WLL daN	Weight ¹ kg	Weight ¹ with locking device kg
HTG 500	*074711	500	A	50 - 220	25	0.9	3	9.7	16.2
HTG 1000	*074728	1000	A	50 - 220	25	0.9	6	11.2	19.2
HTG 2000	*074735	2000	A	66 - 220	25	1.15	7	18.0	26.0
HTG 3000	*074742	3000	A	74 - 220	25	1.4	7	35.4	44.6
HTG 5000	*074759	5000	A	90 - 220	25	1.8	9	51.8	62.3
HTG 500	*074766	500	B	160 - 300	40	0.9	3	12.6	19.1
HTG 1000	*074841	1000	B	160 - 300	40	0.9	6	14.1	22.1
HTG 2000	*074773	2000	B	160 - 300	40	1.15	7	21.3	29.3
HTG 3000	*074780	3000	B	160 - 300	40	1.4	7	39.2	48.4
HTG 5000	*074797	5000	B	180 - 300	40	1.8	9	56.0	66.5
HTG 8000	*074803	8000	B	125 - 310	40	1.8	14	104.0	-
HTG 10000	*074810	10000	B	125 - 310	40	1.8	14	104.0	-
HTG 15000	*074827	15000	B	125 - 310	40	5.0	29	230.0	-
HTG 20000	*074834	20000	B	125 - 310	40	5.0	29	230.0	-

¹Weight HTG: without hand chain



Available in explosion proof version
(see page 460).

Hoisting Equipment Trolleys

Dimensions model HTP

Model	HTP 500-A	HTP 1000-A	HTP 2000-A	HTP 3000-A	HTP 5000-A	HTP 500-B	HTP 1000-B	HTP 2000-B	HTP 3000-B	HTP 5000-B
A, mm	77	82.5	98.5	114	132.5	92	97.5	113.5	129	147.5
D, mm	16	17	22	26	33	16	17	22	26	33
D1, mm	25	30	40	48	60	25	30	40	48	60
D2, mm	30	35	47	58	70	30	35	47	58	70
F1, mm	46	46	46	46	45.5	46	46	46	46	45.5
H1, mm	30.5	30.5	30.5	30	30	45.5	45.5	45.5	45	45
I (HTP), mm	71.5	71.5	95.5	131	142.5	71.5	71.5	95.5	131	142.5
L, mm	260	260	310	390	450	260	260	310	390	450
L1, mm	130	130	150	180	209	130	130	150	180	209
O, mm	60	60	80	112	125	60	60	80	112	125
P1, mm	168	168	168	168	168	168	168	168	168	168
P2, mm	146	150	155	160	167.5	187	187	189.5	191.5	191.5
L3, mm	346	346	396	476	556	346	346	396	476	556

Dimensions model HTG

Model	HTG 500-A	HTG 1000-A	HTG 2000-A	HTG 3000-A	HTG 5000-A	HTG 500-B	HTG 1000-B	HTG 2000-B	HTG 3000-B	HTG 5000-B	HTG 8000-B	HTG 10000-B	HTG 15000-B	HTG 20000-B
A, mm	77	82.5	98.5	114	132.5	92	97.5	113.5	129	147.5	276	276	270	270
B, mm	-	-	-	-	-	-	-	-	-	-	52	52	70	70
D, mm	16	17	22	26	33	16	17	22	26	33	30	30	35	35
D1, mm	25	30	40	48	60	25	30	40	48	60	80	80	110	110
D2, mm	30	35	47	58	70	30	35	47	58	70	114	114	155	155
F (HTG), mm	91.5	91.5	90.5	107.5	149.5	91.5	91.5	90.5	107.5	149.5	113	113	113	113
F1, mm	46	46	46	46	45.5	46	46	46	46	45.5	77	77	-	-
H1, mm	30.5	30.5	30.5	30	30	45.5	45.5	45.5	45	45	45	45	45	45
I (HTG), mm	76.5	76.5	98	132.5	148.5	76.5	76.5	98	132.5	148.5	170	170	170	170
L, mm	260	260	310	390	450	260	260	310	390	450	430	430	870	870
L1, mm	130	130	150	180	209	130	130	150	180	209	200	200	200	200
L2, mm	-	-	-	-	-	-	-	-	-	-	-	-	115	115
O, mm	60	60	80	112	125	60	60	80	112	125	150	150	150	150
P (HTG), mm	110	110	110	110	110	110	110	110	110	110	163	163	163	163
P1, mm	168	168	168	168	168	168	168	168	168	168	193	193	-	-
P2, mm	146	150	155	160	167.5	187	187	189.5	191.5	191.5	-	-	-	-
T, mm	-	-	-	-	-	-	-	-	-	-	270	270	270	270
L3, mm	346	346	396	476	556	346	346	396	476	556	536	536	976	976
P3, mm	194	194	194	195	195	194	194	194	195	195	-	-	-	-

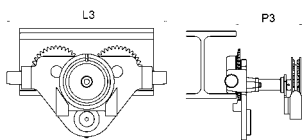

Model HTG 500 - 5000 kg with rotating hand chain guide and buffers

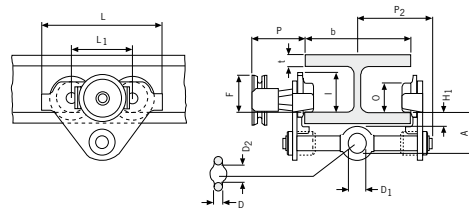

Model HTP/G 500 - 5000 kg

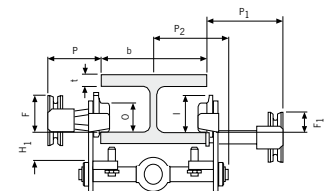

Model HTP/G 500 - 5000 kg, with locking device

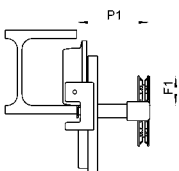

Model HTG 10000 kg, locking device

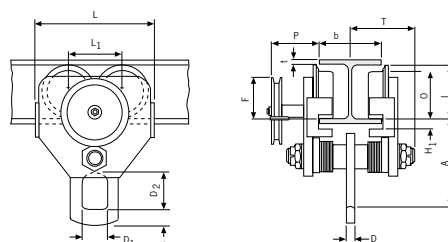

Model HTG 10000 kg

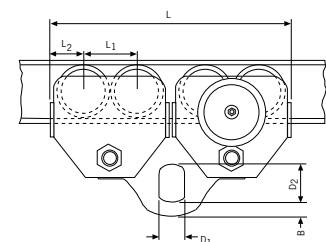

Model HTG 20000 kg

Trolley clamp model CTP

Capacity 1000 - 3000 kg

Easy fitting to overhead beams for the attachment and transport of loads.

Features

- Central threaded spindle provides quick adjustment to the required beam width.
- Threaded spindle and clevis are zinc-plated for added corrosion protection.



Technical data model CTP

Model	EAN-No. 4025092*	Capacity kg	Beam flange width b mm	Curve radius min. m	Weight kg
CTP 1-A	*063012	1000	60 - 150	0.6	2.5
CTP 2-A	*055437	2000	75 - 200	0.9	9.9
CTP 2-B	*055444	2000	200 - 300	0.9	10.3
CTP 3-A	*055451	3000	75 - 200	1.15	17.5
CTP 3-B	*055468	3000	200 - 320	1.15	19.5

Dimensions model CTP

Model	CTP 1-A	CTP 2-A	CTP 2-B	CTP 3-A	CTP 3-B
A, mm	82 - 109	106 - 155	136 - 191	128 - 171	150 - 212
D, mm	26	42	42	50	50
E, mm	22	20	20	22	22
H1, mm	20	24	24	30.5	30.5
I, mm	53	71.5	71.5	95.5	95.5
L, mm	160	260	260	310	310
L1, mm	75	130	130	150	150
M, mm	M12	M18	M18	M24	M24
O, mm	46	60	60	80	80
P, mm	153	205	255	220	280
T, mm	105	139	189	155	215
tmax., mm	15	25	25	25	25

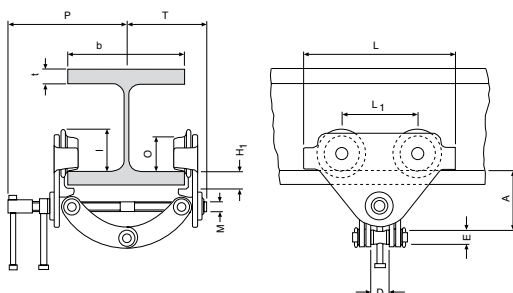

INFO

Yale hoists and trolleys are not designed for passenger elevation applications and must not be used for this purpose.



Electric trolley model VTE-U

Capacity 1000 - 5000 kg

Specially recommended for loads over 1000 kg, for transporting over long distances and/or when used frequently. Suitable for almost all hoists with suspension hook due to universal shackle connection.

Travel motor with worm gear transmission ensures smooth start and self braking – a separate motor brake is not required.

Features

- Standard operating voltage:
Euro-voltage 400V, 3-phase, 50 Hz.
Single speed motors can be reconnected to 230V, 3-phase, 50 Hz.
- Motor protected to IP55 against dust and water jets.
Push-button pendant control IP65.
- Compact, robust frame with low overall height.
- Wheels manufactured from fracture-proof steel. Smooth running due to machined surfaces and ball bearing mounting. Cambered profile suitable for flat and inclined beam profiles.
- Anti-drop and anti-tilt devices as standard.
- Easy adjusted to fit to a wide range of beam widths and profiles due to threaded spindles.

Options

- Low voltage control (42V)
- Rubber buffers
- 230V, 1-phase, 50 Hz



Wheel with cambered profile



Threaded spindle



Anti-drop device with option to fit buffers.

INFO

Yale hoists and trolleys are not designed for passenger elevation applications and must not be used for this purpose.

Technical data model VTE-U

Model	EAN-No. 4025092*	Capacity kg	Travel speed m/min	Motor kW	Beam flange width mm	Beam flange thickness t max. mm	Curve radius min. m	Weight kg
VTE 1-A-18/U ¹	*073547	1000	18 or 18/4.5	0.18 or 0.18/0.06	58 - 180	19	0.9	19.5
VTE 1-B-18/U ¹	*073585	1000	18 or 18/4.5	0.18 or 0.18/0.06	180 - 300	19	0.9	25.2
VTE 2-A-18/U ¹	*073561	2000	18 or 18/4.5	0.18 or 0.18/0.06	58 - 180	19	1.15	26.0
VTE 2-B-18/U ¹	*073608	2000	18 or 18/4.5	0.18 or 0.18/0.06	180 - 300	19	1.15	30.2
VTE 3-A-11/U	*073424	3000	11 or 11/2.8	0.37 or 0.3/0.09	74 - 180	27	1.5	51.0
VTE 3-B-11/U	*073509	3000	11 or 11/2.8	0.37 or 0.3/0.09	180 - 300	27	1.4	53.0
VTE 5-A-11/U	*073448	5000	11 or 11/2.8	0.37 or 0.3/0.09	98 - 180	27	2.0	77.0
VTE 5-B-11/U	*073523	5000	11 or 11/2.8	0.37 or 0.3/0.09	180 - 300	27	1.8	80.0

¹ 11 or 11/2.8m/min. travel speed on request

Dimensions model VTE-U

Model	VTE 1-A-18/U	VTE 1-B-18/U	VTE 2-A-18/U	VTE 2-B-18/U	VTE 3-A-11/U	VTE 3-B-11/U	VTE 5-A-11/U	VTE 5-B-11/U
A, mm	113	113	115	115	139	139	161	161
B, mm	b + 50	b + 50	b + 54	b + 54	b + 60	b + 60	b + 70	b + 70
C, mm	49	49	47	47	57	57	60	60
D, mm	16	16	16	16	19	19	22	22
E, mm	187	187	187	187	202	202	202	202
F, mm	94	94	94	94	94	94	94	94
G, mm	43	43	43	43	51	51	58	58
H, mm	129	129	128	128	144	144	178	178
H1, mm	24	24	24	24	32	32	32	32
I, mm	77	77	98	98	133	133	149	149
L1, mm	130	130	150	150	180	180	209	209
M, mm	155	155	180	180	208	208	263	263
N single speed, mm	255	255	255	255	292	292	292	292
N double speed, mm	263	263	263	263	296	296	296	296
O, mm	60	60	80	80	112	112	125	125
P, mm	123	123	123	123	129	129	121	121
Q, mm	145	205	153	213	160	220	182	242

