

COMEUP WINCH

AUTOMOTIVE WINCH



CE



INSTRUCTION MANUAL

Automotive Winch

Thank you for purchasing a **COMEUP** Winch. This manual covers operation and maintenance of the winch. All information in this publication is based on the latest production information available at the time of printing. We reserve the right to make changes without notice because of continued product improvement.

The winch has been designed to give safe and dependable service if operated according to the instructions. Please read and understand this manual before installation and operation of the winch. Careless winch operation can result in serious injury or property damage.

When requesting information or ordering replacement parts, always give the following information:

1. Winch model and voltage
2. Serial Number
3. Item. No. and Part Number
4. Part Description



1. The winch is a very powerful machine. Treat with extreme care and observe all caution and warnings.
2. The winch is rated at the first layer of wire/synthetic rope on the drum for intermittent-periodic duty.
3. The winch is not to be used to lift, support or otherwise transport personnel.
4. A minimum of five (5) wraps of steel wire rope and of ten (10) wraps of synthetic rope around the drum is necessary to support the rated load.
5. Keep clear of winch, rope, hook, and fairlead while operating.
6. Wire/synthetic rope can break without warning. Always keep a safe distance from the winch and rope while under a load
7. Failure to adequately align, support, or attach the winch to a suitable mounting base could result in a loss of efficiency of performance or damage to the winch, wire/synthetic rope and mounting channel.

To prevent any serious injury, do not install or operate this winch before reading this manual. Keep this manual with the winch at all times. Winch operators must read and understand contents fully. Know the specific function of your winch.

1. Cutout Switch :

Your Seal Gen2 9.5i/9.5si /9.5rsi winches have a cutout switch It is to activate or deactivate the winch.

The cutout switch could also cut out the battery draw of wireless control models when the engine is not running.

2. Vehicle Battery Level :

The dash board of your Seal Gen2 9.5i/9.5si/9.5rsi winch is with battery indicator to show the status of vehicle battery level.



- 1st Icon (Green): Fully charged around 12V level
- 2nd Icon (Green): Fair charged around 11V
- 3rd Icon (Green): Fair charged around 10 V
- 4th Icon (Green): Low charged around 9V
- 5th Icon (Red): Extreme low below 8V

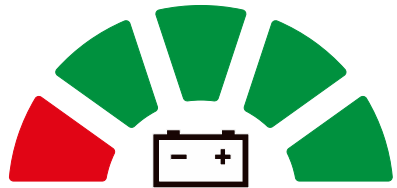

3. Cable in / out direction indicators :

The green triangle icons on the IDB for your Seal Gen2 9.5i / 9.5si / 9.5rsi will indicate the rope winding direction.

a. Cable in: The green triangle icons moved from the outside toward the center indicate the rope winding-in direction.



b. Cable out: The green triangles icons moved from the center toward the outside indicate the rope winding-out direction.



c. Over-heat: The green triangles icons will turn red if the motor is over-heating, but the direction remains unchanged.

4. Over heat Protection :

There are three kinds of overheat protection warnings to protect the motor and control from being damaged or personal injury :

- a. IDB warning: The flashing red temperature icon on (IDB) of your Seal Gen2 9.5rsi winch indicates the motor is over-heating.
- b. Handheld remote warning: The two green LED indicators on the wired remote control will turn red if the motor is over-heating.
- c. Buzzer warning: When motor is over-heating, the Seal Gen2 9.5rs / 9.5rsi / 12.5rs will induce an buzzer alarm



Temperature Warning

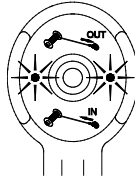

Handheld Remote Warning



Buzzer warning

5. Wireless Remote Control Icon :

- a. While using wireless control, the wireless signal icon of IDB of your Seal Gen2 9.5rsi will turn on.
- b. The LED indicators on the wireless transmitter indicate the signal condition. If green, the signal is good; red is weak.



Wireless Signal Icon

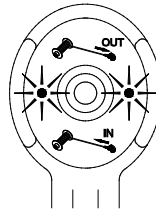

Wireless Transmitter

6. Wireless transmitter's battery life :

If green LED indicator on the wireless transmitter is flashing, the battery of the transmitter need to be replaced.



► **Wireless Receiver & Transmitter Operation**

This wireless remote control device complies with CE mark, FCC and Industry Canada (IC) rules.

CE Mark Warning

- This is a Class B product, in a domestic environment, this product may cause radio interference, In which case the user may be required to take adequate measures.

FCC and Industry Canada (IC) Warning:

- This device complies with Part 15 of the FCC Rules. Operation is subject to the following two conditions: (1) This device may not cause harmful interference, and (2) this device must accept any interference received, including interference that may cause undesired operation.

FEDERAL COMMUNICATIONS COMMISSION INTERFERENCE STATEMENT

This equipment has been tested and found to comply with the limits for a Class B digital device, pursuant to part 15 of the FCC rules.

These limits are designed to provide reasonable protection against harmful interference in a residential installation. This equipment generates uses and can radiate radio frequency energy and, if not installed and used in accordance with the instructions, may cause harmful interference to radio communications.

However, there is no guarantee that interference will not occur in a particular installation. If this equipment does cause harmful interference to radio or television reception, which can be determined by turning the equipment off and on, the user is encouraged to try to correct the interference by one or more of the following measures:

- Reorient or relocate the receiving antenna.
- Increase the separation between the equipment and receiver.
- Connect the equipment into an outlet on a circuit different from that to which the receiver is connected.
- Consult the dealer or an experienced radio / TV technician for help.











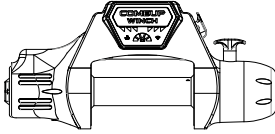
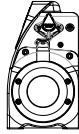

CAUTION:

Any changes or modifications not expressly approved by the grantee of this device could void the user's authority to operate the equipment.









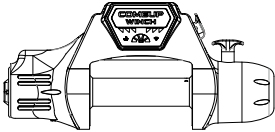
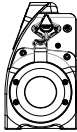
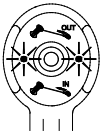

- ▶ There are four control modules of Sean Gen2 series winches. All are similar in setup, but with differing responses in regards to their control type.
 - 1). Seal Gen2 9.5rsi :
 - a. With both wireless and wire remote control.
 - b. IDB with wireless remote control function + cut out switch + temperature warning and overheat buzzer warning.
 - c. After activating the winch, the logo LED will light on and battery indicator shows the status of battery level. At the same time, the wireless remote control icon will be blinking with buzzer warning until the remote control is tuned.
 - d. Cable in / out direction indicators.
 - 2). Seal Gen2 9.5i / 9.5si :
 - a. With wired remote control.
 - b. IDB with wireless remote control function + cut out switch + temperature warning and overheat buzzer warning.
 - c. Cable in / out direction indicators.
 - 3). Seal Gen2 9.5rs :
 - a. With both wireless and wire remote control.
 - b. Overheating buzzer warning.
 - 4). Seal Gen2 9.5 / 9.5s :
 - a. With wire remote control.

► Seal Gen2 9.5rsi with IDB, cut out switch and buzzer warning.

1).Wireless remote control module :

Applicable models		Seal Gen2 9.5rsi					
LED & Buzzer							
		LOGO				Transmitter LED	
Turn on		on	on	Blinking	2 short beeps for 1 minutes	X	
Press Transmitter for 5 seconds				X	Blue	Long beeps for 5 seconds	Turn on Green
Programming							
If programming failed , Winch will automatically use the previous programming after 1 minute.							
Cable in / IDB LED (Green)					X	Red	
Cable out / IDB LED (Green)							
 (Blinking)	Cable in / IDB LED (Red)				2 short beeps every 5 seconds		
	Cable out / IDB LED (Red)						
	No operation					Green	
Low voltage on transmitter		Light on	Light on	Light on	X	Green	
Poor signal warning				Red			
Press the power button for 5 seconds to turn transmitter off.				X		X	
Press the power button to turn winch off.		X				X	



2).Wired remote control module :

Applicable models		Seal Gen2 9.5i / 9.5si / 9.5rsi				
LED & Buzzer						
		LOGO				Remote Control LED
Press the power button to turn winch on.		Light on	Light on	Blinking (remark 1.)	2 short beeps for 1 minutes (remark 2)	X
Plug in connector						Green
Cable in / IDB LED (Green)					X	Green
Cable out / IDB LED (Green)						
Motor overheating warning  (Blinking)	Cable in / IDB LED (Red)				2 short beeps every 5 seconds	Red
	Cable out / IDB LED (Red)					
	No operation	Light on	Light on	Light on (remark 3)		
Press the power button to turn winch off.		X				

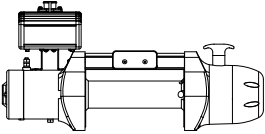

Remarks:

1. Seal Gen2 9.5i / 9.5si: No wireless signal icon.
2. Seal Gen2 9.5i / 9.5si: Buzzer won't be activated accordingly.
3. Seal Gen2 9.5rsi: Turn winch on, winch will automatically use the previous programming.

3).Wireless remote control with wired remote control (2 LEDs on wired remote control and buzzer in the control box), For Seal Gen2 9.5rs / 12.5rs only :

Applicable models		Seal Gen2 9.5rs / 12.5rs		
LED & Buzzer				
		Buzzer	Transmitter LED	Remote Control LED
Press the power button on transmitter for 5 seconds to turn transmitter on.		X	Green	X
Cable in / out operation		X	Red	Green
Motor overheating warning	Cable in / out	2 short beeps every 5 seconds	Red	Red
	No operation		Green	
Low voltage on transmitter		X	Blinking green	X
Poor signal warning		X	Blinking red	X
Press the power button of transmitter for 5 seconds to turn transmitter off.		X	X	X

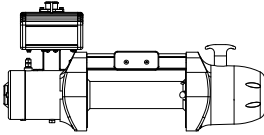
4).Wired remote control (2 LEDs on remote control), For Seal Gen2 9.5 / 9.5s / 12.5 / 12.5s only :

Applicable models		Seal Gen2 9.5 / 9.5s / 12.5 / 12.5s	
LED & Buzzer			
		Buzzer	LEDs on remote control
Plug in connector		X	Green
Cable in / out operation		X	Green
Motor overheating warning		X	Red
Plug out connector		X	X

► **Power in the winch (Getting started)**

1. Cut out Switch :

Your Seal Gen2 9.5i / 9.5si / 9.5rsi winches can be activated by the cut out switch.

- 1.1 Press the cutout switch button to activate the winch operation. Verify a red light appears around the button.
- 1.2 The white COMEUP winch logo icon will bright up for Seal Gen2 9.5i / 9.5si / 9.5rsi, battery indicator icons will light on in green.
- 1.3 The wireless control device is in tuning.

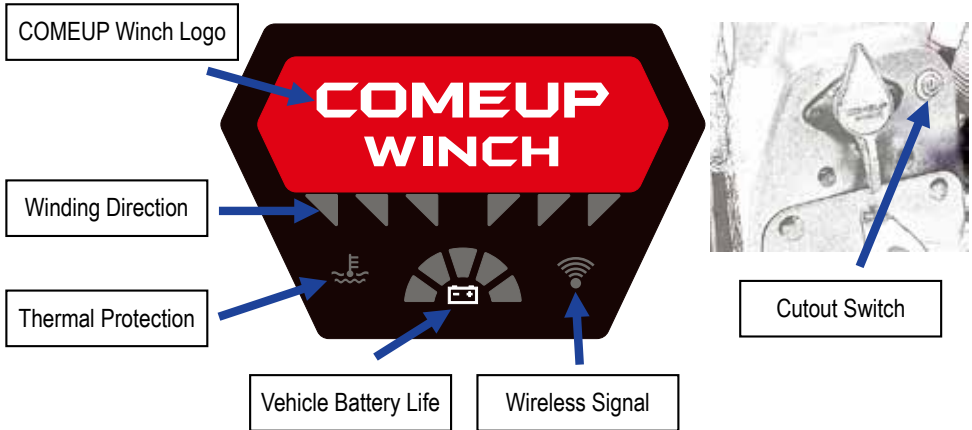

2. Hand-held switch :

All automotive winches are supplied with a wired remote control to activate and operate the winch. Two green LEDs indicator the winch is under operation.

3. Wireless Transmitter :

Your Seal Gen2 9.5rs / 9.5rsi / 12.5rs and optional wireless transmitter for other automotive winches can be operated by wireless remote control.

Press and hold the power button for 5 seconds to activate winch operation. The green LED Indicator lights up.

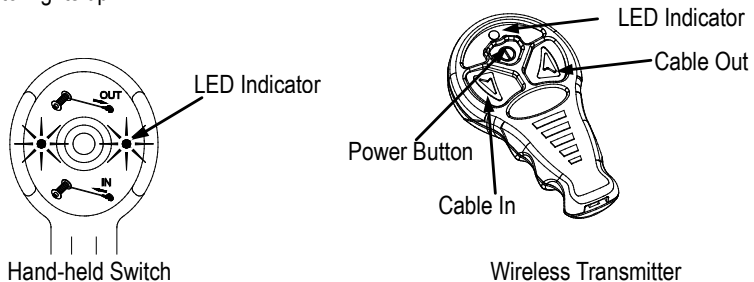

► **Battery replacement**

When the green LED Indicator is flashing indicates an extreme low battery level of wireless transmitter's. The battery should be replaced.

1. Loose the three screws from the back cover of the wireless transmitter.
2. Separate the top section and remove the old battery and dispose it.

3. Insert new 3V lithium battery and join the top section with the bottom section.
4. Make sure to fasten the three screws.

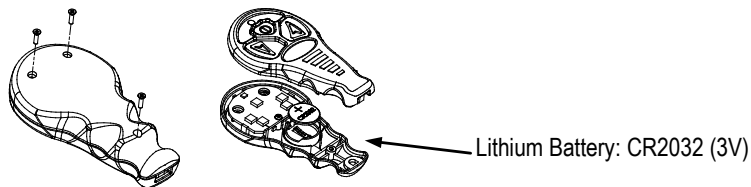

► Pairing the wireless remote control

Your wireless remote control is already paired to your winch, however a replacement will need to be paired.

1. Attach the winch power red lead to the positive (+) battery terminal and attach black ground lead to the negative (-) battery lead, the buzzer beeps for 5 minutes
2. Press and hold the power button for about 5 seconds, the LED Indicator illuminates green permanently.
3. Press either cable in button or cable out button for pairing. The blinking LED indicator will light up while pairing
4. If pairing was successful, The LED indicator lights up and the buzzer sounds a long beep lasting for 5 seconds
5. If pairing was unsuccessful after 5 minutes, the power LED indicator will turn off and it need to restart the pairing.

► Power Off the winch (Shut down)

1. Cutout Switch :

Press the cutout switch button to terminate your Seal Gen2 9.5i/9.5si/9.5rsi winches operation.

2. Wireless Transmitter :

- 2.1 Press and hold the power button for 5 seconds for wireless controlled winches.
- 2.2 The green LED indicator at the wireless transmitter will turn off after winch shutting down.
- 2.3 The winch will be shut down automatically if at idle for 5 minutes.

► Battery Recommendations and lead size

A fully charged battery and good connections are essential for the proper operation of your winch. The minimum requirement for battery is 650 cold cranking amps. The voltage drop for the winch motor must not exceed 10% of the nominal voltage of 12/24V DC.

The battery lead shall be 2 gauge with 1.83 m in length at most, otherwise a considerable voltage drop will be happened.

► Wiring Diagram

Attach the black lead firmly to the negative (-) battery terminal and red lead to the positive (+) battery terminal. The voltage drop for the winch motor must not exceed 10% of the nominal voltage of 12 / 24V DC.

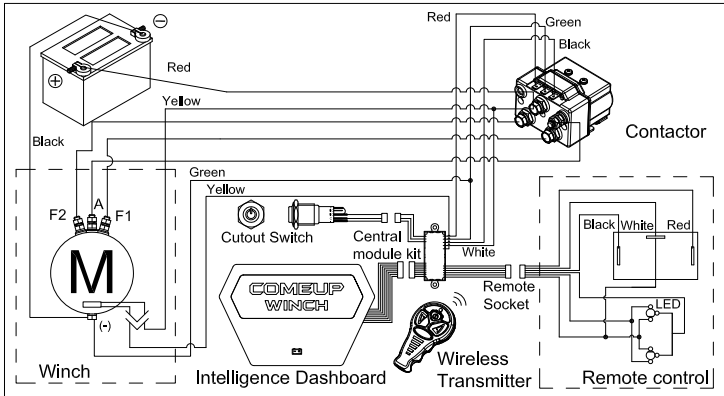

► **Cable-in / Cable-out Operation**

1. **Wired Remote Control :**

- 1.1 To “ winch or cable - out”, trigger → out.
- 1.2 To “ winch or cable - in”, trigger ← in.
- 1.3 To stop winching, release the trigger.

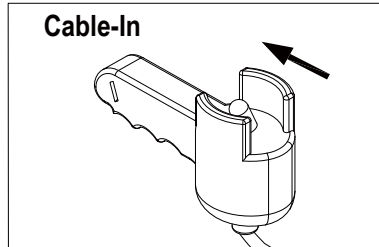
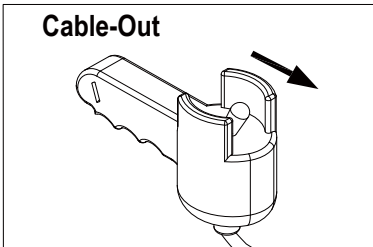

2. **Wireless Control Module :**

- 2.1. Press and hold the cable in button of the transmitter for rope winding in operation.
- 2.2. Press and hold the cable out button of the transmitter for rope winding out operation.
- 2.3. Stop winching, release the cable in or cable out buttons.

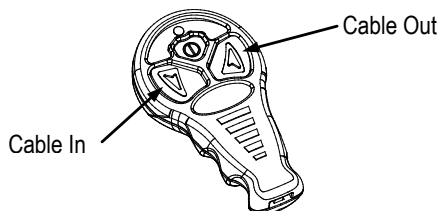

► Shut Down the Winch Permanently

1. Cutout Switch :

Press the cutout switch button to activate the wired controlled winch operation. Verify a redlight turns off.

2. Wired Remote Control :

Remove the hand-held switch from the winch when not in use.

► Clutch Function

1. The clutch allows rapid pay-out of the wire/synthetic rope for hooking onto a load or anchor points and is operated by a clutch T-handle.
2. The clutch T-handle must be in the “Engaged” position before winching.
3. To disengage, Lift the clutch T-handle up and turn it at the proper angle mentioned in the
4. mounting configurations chart below in a counter-clockwise direction to the “Disengaged” position. Wire / synthetic rope can now free spool off the drum.
5. To engage, Lift the clutch T-handle up and turn it at the proper angle mentioned in the mounting configurations chart below in a clockwise direction to the “Engaged” position.
6. If a clutch T-handle can’t be properly locked in the “Engaged” position, Rotate the drum to
7. help the clutch device engage the gear train.
8. Wear gloves and use a hand saver strap when guiding the wire / synthetic rope off the drum.
9. Never disengage the clutch while wire / synthetic rope is under load.

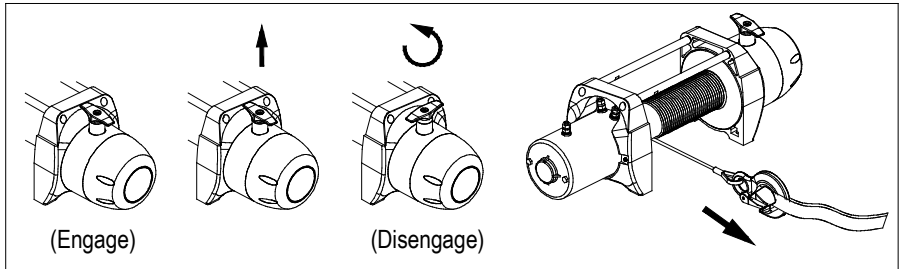

► Motor Repositioning

Change the motor mounting direction according to the following steps.

1. Use a piece of 11 mm wrench and loose 2 pieces of screw.
2. Hold the motor to avoid any escape. Loose and take away 2 pieces of screw located at motor edge place.
3. Pull the motor backward by 5mm for escaping the positioning pin and rotate the motor by 90 degree increments to the required position.
4. Re-assembly 2 pieces of screw to the motor edge place and tighten them after the motor and position pin reaching their positioning places.

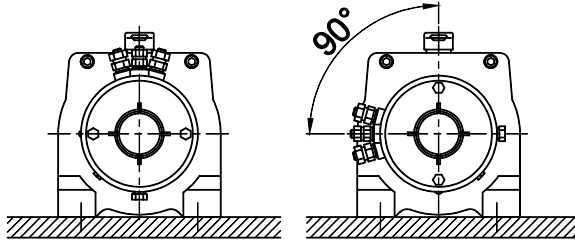

► Clutch Repositioning

Change the position of the Free-Spool T-handle according to the following steps.

1. Loosen and release the bolts on the brake rear cover for separating the brake rear cover away.
2. Loosen and release the bolts on the gearbox away for separating the gear box away (Only for Seal Gen2 series winches).
3. Rotate the gearbox by a proper angle increments mentioned on the below chart to the required position.
4. Re-assembly the gearbox and rear brake cover.

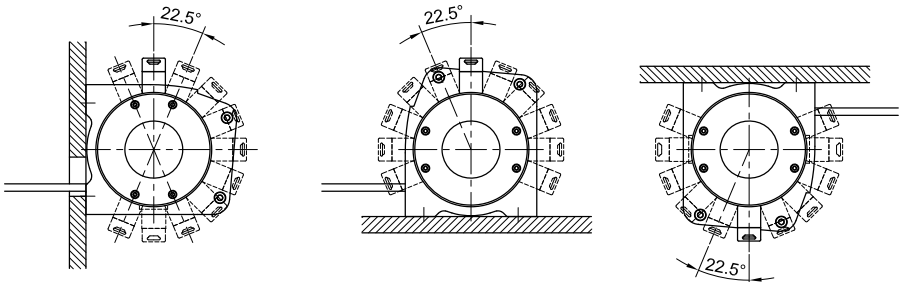

► Mounting Configurations

The payout direction for wire rope/synthetic rope or the correct methods for mounting the winch vary according to different winch model. Do wind the rope from the bottom of the drum. At any condition, do not position the load direction away from the mounting base plate.

Winch Model	Mounting Position		Repositioning	
	Foot Down	Foot Forward	Clutch Angle	Motor Angle
Seal Gen2 9.5/9.5s/9.5rs	V	V	22.5°	90°
Seal Gen2 9.5i/9.5si/9.5rsi	V	V	22.5°	90°
Seal Gen2 12.5/12.5s/12.5rs	-	V	22.5°	90°
DV-18	-	V	36°	90°
DV-12/15	V	V	36°	90°
DV-12 light/12s light	-	V	40°	90°
DV-9/9s/9i/9si/Cap 9.0s	V	V	40°	90°
DV-6/6s/6s carry on	V	V	-	90°
Walrus 16.5/20.0	-	V	90°	-

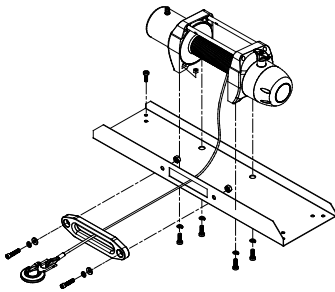

Foot Down Mounting Position

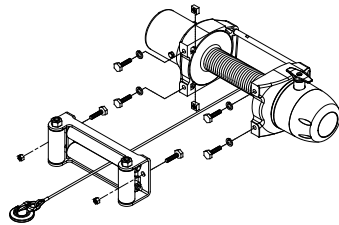

Foot Forward Mounting Position

- ⚠ In some cases, the operator of a winch may be required to have qualifications according to applicable laws and ordinances.
- ⚠ Check safety and environmental conditions prior to and during use.
- ⚠ Only use correctly rated wire/synthetic rope in construction, strength. Inspect for damage and/or defects before use.
- ⚠ Don't use an unsuitable hook and snatch block for rope.
- ⚠ The operator must remain with the winch during operation.
- ⚠ The winch duty rating is S3 (intermittent-periodic).
- ⚠ Do not use the winch as a lifting device or a hoist for vertical lifting and moving people.
- ⚠ Ensure that the winch is connected to the correct voltage. 12/24 VDC only.
- ⚠ Do not exceed maximum line pull ratings. Shock load must not exceed these ratings.
- ⚠ Keep hands clear of rope and fairlead opening.
- ⚠ Pull from an angle below 15° in the horizontal plane to straighten up the vehicle or load.
- ⚠ Always use leather gloves when handling the wire/synthetic rope.
- ⚠ When winching, always use a recovery damper. Place over the wire/synthetic rope in the middle third of its length.
- ⚠ A rope should be replaced if it shows signs of excessive wear, broken strands, corrosion for wire rope and excessive abrasion, broken strands, fused and melted fiber for synthetic rope.
- ⚠ If the winch fails to pull a load under normal conditions, stop the operation, otherwise motor damage may occur. The thermal indicator LEDs in the control box or remote switch will indicate RED as a warning.
- ⚠ Check that the clutch T-handle is in the "Engaged" position during and after use.
- ⚠ Remove the switch from the winch when not in use.
- ⚠ Do not wrap the wire/synthetic rope around the load and back onto itself. Always use a tree truck strap.
- ⚠ Keep hands and clothes away from the winch, rope, and roller/hawse fairlead.
- ⚠ Never unplug the remote control when winching a load.
- ⚠ To avoid insufficient power when winching a load, the vehicle should be running and in neutral.
- ⚠ If noise or vibration occurs when running, stop the winch immediately and return it for repair.
- ⚠ The rope shall be wound in according to drum rotation sticker or refer to owners manual.

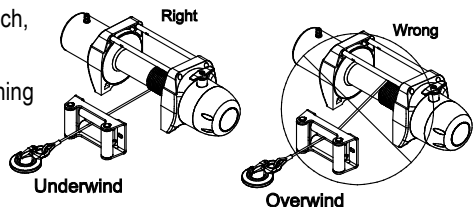
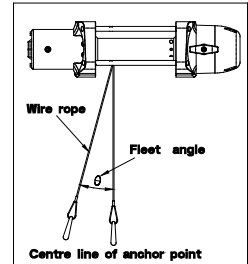
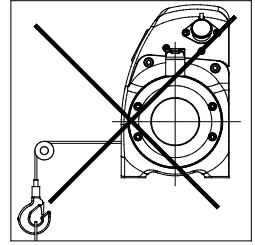

► Calculating Fleet Angle

To obtain the best wire/synthetic rope service, the direction of pull will be on a horizontal within ± 15 degrees and perpendicular to be centerline of the winch drum within ± 5 degrees. If the fleet angle is bigger than the recommended angles, a good spooling cannot be obtained as the rope will spoon onto one side of the rope drum and possible damage to the rope or winch.

► Load Rating

Load and speed varies according to how much wire/synthetic rope is on the drum. The first layer of rope on the drum delivers the slowest speed and the maximum load. A full drum delivers the maximum speed and the minimum load.

For this reason, all automotive winches are rated at their first layer capacities.

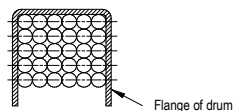
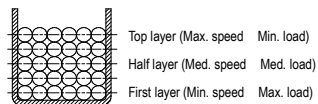

► Required Pulling Force

You need a winch powerful enough to overcome the weight of your vehicle with the added resistance caused by the obstacle, moving water, mud, snow, sand or on a steep hill.

As a general guide, you need a winch with a maximum line pull of at least 1.5 times greater than the gross vehicle weight.

There are three factors listed that influence the line pull effect required to recover the vehicle. The values and calculations in this section are approximate and are for reference only.

- Gross vehicle weight
- Type of the surface to be traversed
- Gradient to overcome

In recovery and loading the winch is used to pull something, the required pulling force (RPF) can be calculated according to the formula:

$$RPF = (Wt \times S) + (Wt \times G)$$

Where: Wt = The gross vehicle weight
 S = The type of the surface to be traversed
 G = The gradient to overcome

Surface Type	Surface Drag (S)
Metal	0.15
Sand	0.18
Gravel	0.20
Soft Sand	0.22
Mud	0.32
Marsh	0.52
Clay	0.52

Gradient	Angle (θ)	Gradient (G)
5%	3°	0.06
10%	6°	0.11
20%	11°	0.2
30%	17°	0.3
50%	26°	0.44
70%	35°	0.58
100%	45°	0.71

For example, if a vehicle weighing 3,000 kg is winched up an incline by 100% on the marsh road, the above formula would be used as follows:

Where Wt: 3,000 kg, S: 0.52 G: 0.71

$$\begin{aligned} \text{RPF} &= (\text{Wt} \times \text{S}) + (\text{Wt} \times \text{G}) \\ &= (3,000 \text{ kg} \times 0.52) + (3,000 \text{ kg} \times 0.71) \\ &= 1,560 \text{ kg} + 2,130 \text{ kg} \\ &= 3,690 \text{ kg of effect required to recover the vehicle.} \end{aligned}$$

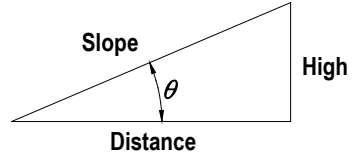

A gradient of 10% is a rise of one meter in ten meters (High / Distance)

► Securing Anchor Point

When choosing an anchor point, select a safe and firm point such as a tree, stump or rocks. If using a winch to retrieve another vehicle, the rescue vehicle is considered the anchor point and should be made secure.

The anchor point must be strong enough to hold the gross weight of the vehicle and be positioned to keep the fleet angle between the centre of the anchor point and the wire/synthetic rope maintained less than 15° . Always use a tree trunk protector strap to prevent ring barking the tree and damaged to the wire/synthetic rope.

► Winching V.S. Hoisting. A pulling winch should not be used for lifting.

Please refer to our website to view our full range of lifting winches.

► **Roller Fairlead**

The use of 4 ways roller fairlead can eliminate the contacting friction because the fairlead rollers contact with the wire rope. But the fairlead does not insure the wire rope will wind onto the drum in an orderly manner. The proper fleet angle within 15° must be maintained for the wire rope to wind onto the drum in an orderly manner. If the proper fleet angle is not maintained, it can result in damage to the winch and wire rope.

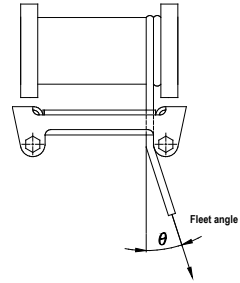

► **Hawse Fairlead**

The basic hawse fairlead is designed to guide the synthetic rope to and from the winch drum. Do not use cast steel hawse fairleads as they have sharp edges and they do not have enough radius for the rope to bend over.

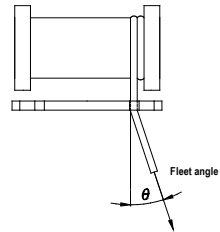

► **Recovery Damper**

A recovery damper is a safety device designed to help eliminated the possibility of injury or property damage in the event of a wire/synthetic rope failure. Place in the middle third of a live rope. The damper can help absorb the energy in the rope and reduce the likelihood of injury or damage.

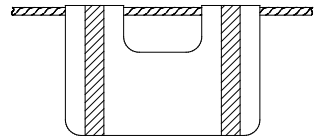

► **Snatch Block**

An important aid to successful winching is the use of snatch block, which can be used to increase the pulling power of a winch or change the direction of a pull.

A winch double lined with a snatch block creates a mechanical leverage cutting the effort required by nearly half.

The double line pull shows self recovery using a snatch block attached to an anchor point; the pull applied to the vehicle is almost twice as much as the line pull of the winch.

The use of one snatch block shows an indirect pull where the vehicle is limited due to unsuitable ground or obstruction. The pull on the load is the actual line pull of the winch. If more than one snatch block is used, they must be located at least 100 cm (40") apart.

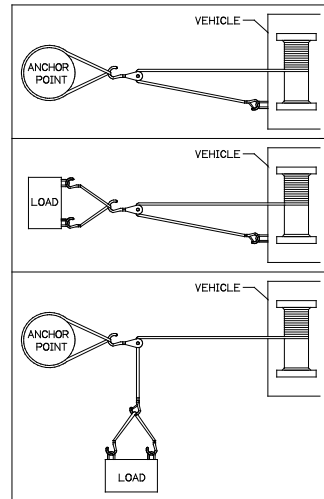

► Preparation before Winching

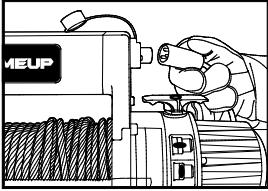

- 1. Connect the remote control**
Always disconnect the remote control when not in use. Always have the remote control kept free from winch, wire/synthetic rope and roller/hawse fairlead.

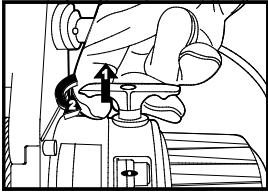

- 2. Disengage clutch function**
Lift the clutch T-handle up and turn it at 90° counter-clockwise rotation to the "Disengaged" position, rope can now clutch off the drum.

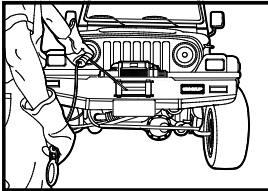

- 3. Pull the wire/synthetic rope to the anchor point**
Wear leather gloves when handling wire/synthetic rope. Pull out enough rope to reach the anchor point. Be careful to keep the rope under tension.

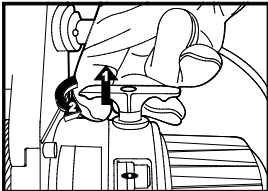

- 4. Engage clutch function**
To engage, lift the clutch T-handle up and turn it at 90° clockwise rotation to the "Engaged" position. Never engage the clutch while the drum is rotating.

► Winching Operation

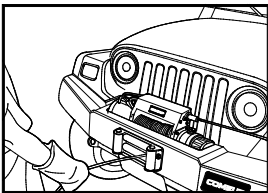

- 1. Check the wire/synthetic rope**
Before winching, make sure the rope is wound on the drum evenly. If there is a mixed winding, it is essential to rewind it evenly.

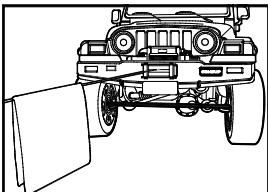

- 2. Lay a recovery damper over the rope near the hook end.**
If a wire/synthetic rope failure occurs, the damper can prevent the rope from whipping.

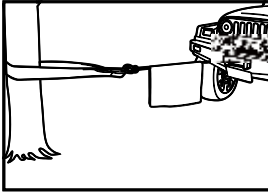

3. Secure anchor point

It is very important that an anchor point is strong enough to hold the load while winching. Do not wrap the rope around the load and back onto itself. Always use a strap to ensure that the wire/synthetic rope does not fray or kink.

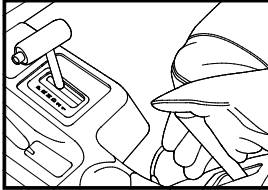

4. Setting the vehicle engine

The recovery vehicle engine should be running to provide maximum power to the winch. The transmission shall be set in park, hand brake applied and wheel chocked or vehicle anchored to prevent the vehicle from moving.

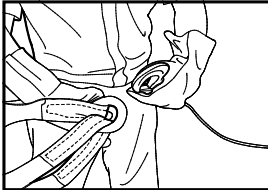

5. Attach shackle and hook

Use a shackle to lock both ends of tree trunk protector, and then attach to the wire/synthetic rope hook.

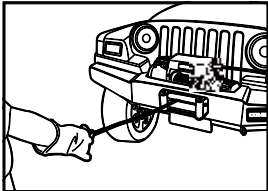

6. Begin winching

Keep force on the rope to ensure it winds onto the drum evenly.

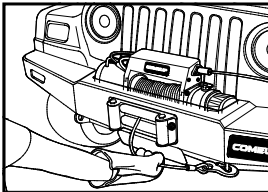

7. Secure vehicle

Once the vehicle is secured, wind the rope back onto the drum evenly and secure the hook firmly.

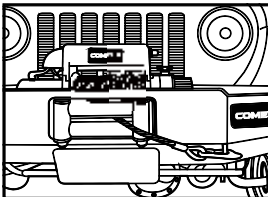

8. Disconnect remote control

Take remote control out of the socket and store it in a safe and dry place.



Make sure the rope is wound on the drum evenly. A tightly spiraled pig-tailed rope will damage the rope, shorten its life.

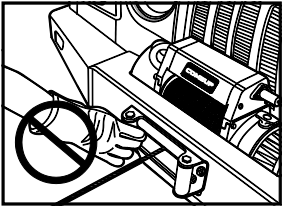

Always keep clear of winch, rope, hook, and roller/hawse fairlead during winching.



Keep winching area clear. Do not allow people to remain in the area while winching.

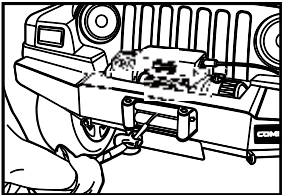

Never guide a wire/synthetic rope onto the drum with your hand, use a hand saver strap.

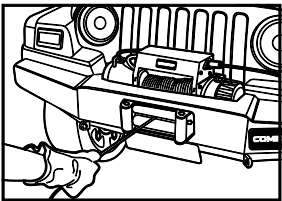

Avoid remote control cord from touching the wire/synthetic rope.

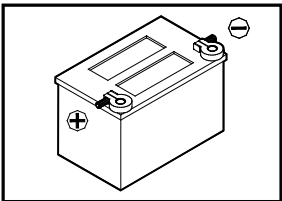

A winching operation requires extra consumption of battery power, so always keep your battery set in a good condition.

► **Wire Rope Replacement**

Do not wind out past the red paint section of the rope to secure the anchorage of the rope on the drum.

1. Disengage the clutch T-handle.
2. Spool the entire rope, and then remove it from the drum.
3. Place the replacement rope through the roller fairlead opening, pass below the drum and insert it into the hole on the drum core. Tighten the set-screw downwards to secure the wire rope.
4. A minimum of five (5) wraps of rope around the drum is necessary to support the rated load.

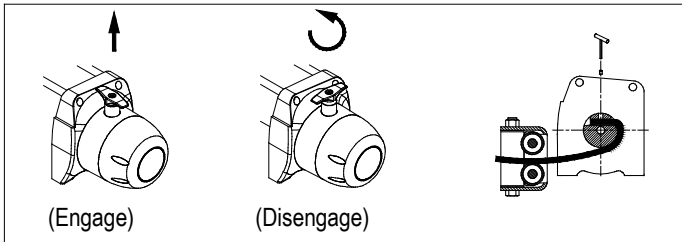

► **Synthetic Rope Replacement**

Do not wind out past the red paint section of the rope to secure the anchorage of the rope on the drum.

1. Disengage the clutch T-handle, remove existing rope and replace hawse if necessary.
2. Remove the set-screw on the drum and spool out the rope from the drum.
3. Cut the lateral side of the end by 45° and apply 2-3 wraps of electrical tape to hold cut strands in place.
4. Thread rope through a hawse fairlead and under the drum, insert the rope through the hole on the drum with 15 – 20 cm / 6" – 8".
5. Place rope across the drum and tape the end down to hold it in place. Lightly tighten the set-screw to squeeze the rope, do not over tighten.
6. A minimum of ten (10) wraps of rope around the drum is necessary to support the rated load.

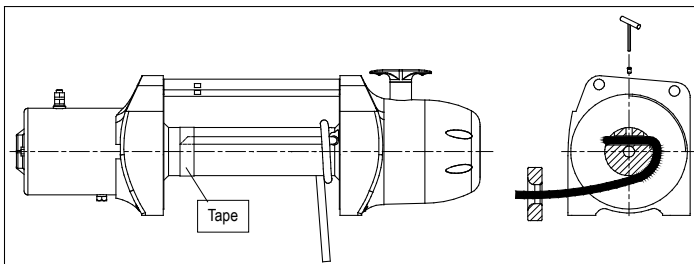

► **Tip for prolonging the life of Synthetic rope**

1. Regular maintenance and periodically check the rope for damage or wear.
2. Since too much abrasion can damage or weaken your synthetic rope, protect your rope from rubbing against sharp objects or edge.
3. An aluminum hawse fairlead is highly recommended since it has no sharp edges and resists damage more easily than a roller fairlead.
4. Keeping your synthetic rope clean and dry. To clean it after a muddy ride, spool out the rope, rinse it with a hose, and let it dry completely before re-spooling.

► **Brake Adjustment**

Under normal use, the brake mechanism will not require any adjustment. If the brake fails to hold a load, the brake disc may be worn and require replacement. When the brake wears to the point that the load begins to slip, the brake can be adjusted as follows:

1. Loosen the bolt on the brake cover and take out the retaining rings.
2. Insert spacers/washers to maintain the brake spacer between to be 2.2 ± 0.25 mm.
3. Make sure to keep the clutch base plate is rotated counter-clockwise by 150 – 180 degree.

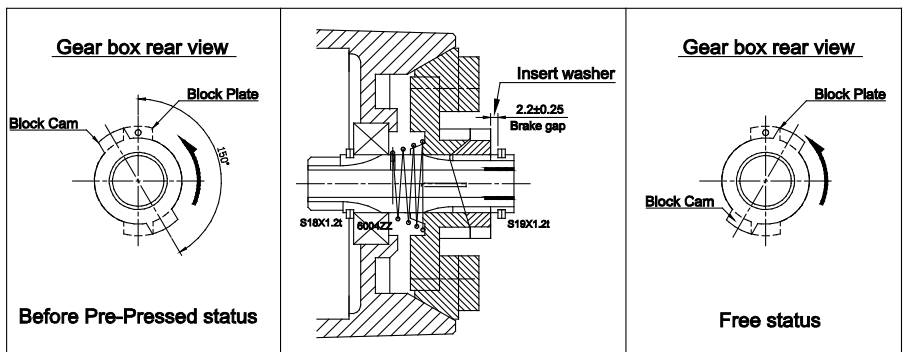

► **Lubrication**

All moving parts in the winch are permanently lubricated at the time of assembly. Under normal conditions factory lubrication will suffice. If re-lubrication of gear box is necessary after repair or disassembly use Shell EP2 or equivalent grease with enough quantity. Clutch T-handle lubricates regularly with light oil. It is not allowed to have brake assembly lubricated.

► Maintenance Schedule

Classification of check			Item	Checking method	Checking reference	
Daily	Periodical					
	Monthly	Quarterly				
○			Installation	Mounting bolts & alignment	Bolt tension & wear	Existence of abnormalities
○			Remote control	Working	Manual	Reasonable actuation
		○		Wearing in contact points	Visual	Free of wear or damage
○				LED lights red	Visual	LED light green
○			Wire rope	Broken strands	Visual,	Less than 10%
○	○			Decrease in rope diameter	Visual, measuring	7% of nominal diameter max
○				Fastening condition of end	Visual	Existence of abnormalities
○				Deforming or corrosion	Visual	Existence of abnormalities
○			Synthetic rope	Broken strands	Visual, measuring	Two or more adjacent strands are cut
○	○			Decrease in rope diameter	Visual, measuring	25% of nominal diameter max
○				Fused or melted fibers	Visual	Existence of abnormalities
○				Fastening condition of end	Visual	Existence of abnormalities
		○	Clutch assembly	Damaged clutch assembly	Visual evidence of wear	Free of wear or damage
		○	Motor	Staining, damage	Visual evidence of wear	Existence of abnormalities
		○	Brake	Wearing of brake disc	Visual evidence of wear	Free of wear or damage
○				Performance	Visual	Reasonable actuation
		○	Gear	Damage, wearing	Visual evidence of wear	Free of wear or damage

If the winch fails to operate after several attempt, or if there is any fault whilst operation:

Symptom	Possible Cause	Remedy
Winch will not operate	Cut circuit	Check battery lead
	Weak battery	Recharge or replace battery, 650CCA
	Damaged over-load protector(option)	Replace over-load protector(option)
	Bad connection of wiring	Reconnect tightly
	Damaged contactor	Replace contactor
	Cut circuit on switch	Replace switch
	Damaged motor or carbon brush.	Replace motor or carbon brush
Motor runs in one direction.	Poor or lost connections to motor	Replace wiring or tighten it
	Broken wiring or bad connections	Reconnect or replace wiring
	Damaged or stuck contactor	Replace contactor
Drum will not clutch.	Switch inoperative	Replace switch
	Clutch does not disengage	Replace clutch
	Damaged 1 st shaft	Replace 1 st shaft
	Damaged brake cam and disc	Replace brake cam and disc
No brake	Damaged output shaft	Replace output shaft
	The gear train is mechanically binding up	Check to insure the winch is mounted on a flat, rigid surface
	Damaged brake cam and disc	Replace brake cam and disc
	Damaged gear box	Replace gear box
	Broken retaining ring	Replace retaining ring
Brake distance is too long	Oil leakage into brake cavity	Repair and clean oil leakage
	Damaged or inoperative spiral spring	Replace and position spiral spring
	Worn brake disc or loose brake spacer	Replace brake disc or adjust brake spacer according to brake adjustment procedures
Brake will be locked	Oil leakage into brake cavity	Repair and clean oil leakage
	Too much brake disc powder in the brake hub	Clean brake hub
	Over tensioned spiral spring	Adjust tension on spiral spring
Damaged gear box	Stuck between brake disc and gear box	Replace with new brake assembly
	Hit by certain exterior force	Replace the damaged components
	Damaged gear train	Replace the damaged components
Motor runs extremely hot	Over load operation	Stop the winch operation and reduce the load
	Long period of operation	Allow to cool
	Damaged motor	Replace or repair motor
LED lights red in the remote switch	Damaged or inoperative brake	Replace or repair brake
	Overheating of the motor	Stop the winch operation and cool the motor

Limited Lifetime Warranty for Mechanical Components Limited One (1) Year Warranty for Electrical Components

WARRANTY

Comeup Industries Inc. (COMEUP) warrants to the original purchaser that the mechanical components of the COMEUP Automotive Winch will be free of defects in material and workmanship for the lifetime of the winch and the electrical components will be free of defects in material and workmanship for a period of three (3) years for Seal Gen2 winches and of one (1) year for other automotive winches from the original date of purchase. All COMEUP mounting kits and other accessories carry a one (1) year limited warranty against defects in material workmanship.

This warranty applies only to the original purchaser of the winch. To obtain any warranty service, the purchaser under this Limited Warranty is requested to advise COMEUP or its authorized distributors on any claim. The purchaser must provide a copy of the purchase receipt bearing the winch serial number, date of purchase, owners name, email or Tel & Fax, address and purchaser vehicle details. Any products that COMEUP determines to be accountable for defective will be repaired or replaced or refund at COMEUP sole discretion without charge to buyer upon buyer's compliance with these procedures. In the event of repair or replace, purchaser must send the defective winch or part, with freight prepaid, to COMEUP or its authorized distributor. And COMEUP will send the serviced product back to purchaser on COMEUP's cost. This warranty does not cover the removal or reinstallation of the winch.

COMEUP takes the responsibility for COMEUP winch parts and components to be free from defects in materials and workmanship, but the following portions are hereby excluded and disclaimed. COMEUP or its authorized distributors may make reasonable charges for parts and labour for repairs or resumption in the following portions not covered by this limited warranty.

- (1). All warranties of wire rope and synthetic rope assemblies after initial use
- (2). All warranties of fitness for a particular purpose
- (3). All warranties of the product's finish
- (4). All warranties of merchantability

The limited warranty does not cover any failure that results from improper installation/operation, third party part substitution, purchaser's alteration or modification on COMEUP winch. This warranty is void when COMEUP serial number plate is removed or defaced.

COMEUP's liability to the purchaser under the winch purchases for any loss or damage howsoever and whatsoever arising shall not exceed the price of the initial winch purchase receipt. COMEUP shall not in any event be liable to the purchaser for any consequential and/or indirect loss or damage whether for loss or for profit or otherwise, costs, expenses or other claims for consequential compensation whatsoever and whether caused by negligence of COMEUP employees, distributors and their employees or otherwise. COMEUP reserves the right to change product design without notice. In situations in which COMEUP has changed a product design, COMEUP shall have no obligation to upgrade or otherwise modify previously manufactured products.

COMEUP WINCH

COMEUP INDUSTRIES INC.

No.139, Jieyukeng Rd., Ruifang Dist.,

New Taipei City 22453, Taiwan

Tel: +886-2-24971788 / Fax: +886-2-24971699

E-mail: info@comeup.com.tw

<http://www.comeupwinch.com>

PN 882287 Ver:03

Specifications subject to change without notice.