

Pacific Load Skates

The Pacific Load Skates are designed to facilitate the moving, positioning or installation of a wide range of loads, including heavy equipment, machinery and bridge structures. The optional turntable and positioning handle ensure that these load skates are suitable for many applications.



Features:

- Designed to facilitate the moving, positioning or installation of a wide range of loads.
- Manufactured of high quality steel for a durable product finish.
- Optional turntable and positioning handle available for all models.
- Collapsible positioning handle for easy storage.
- High visibility colours for safety purposes.
- Overall better design and improved finish to prolong product longevity.

The information shown is to be used as a guide only. Specifications are subject to change without notice. All materials handling or lifting jobs should be assessed individually. Pacific Hoists products are NOT to be used for lifting or lowering persons.

Specifications

Model		LSK005	LSK010	LSK020	LSK035	LSK050	LSK075
Capacity per 4 units (tonne)		5	10	20	30	50	75
Capacity per unit (tonne)		1.25	2.5	5	7.5	12.5	18.75
Unit Length (mm)	A	190	206	228	228	279	292
Unit Width (mm)	B	99	99	99	99	145	145
Unit Height (mm)	C	65	65	65	65	97	97
Unit Track Width (mm)	D	55	55	55	55	100	100
Unit Roller Diameter (mm)	E	20	20	20	20	30	30
Unit no. of Rollers	F	12	14	16	16	14	14
Unit rollers in contact		4	5	6	6	6	6
Unit Weight (kg)		4.3	4.9	5.6	5.6	17.5	18
Stock Code Turntable		LSK120	LSK120	LSK120	LSK120	LSK175	LSK175
Unit Height with Turntable (mm)		100	100	100	100	145	145
Unit Turntable Top Diameter (mm)		100	100	100	100	143	143

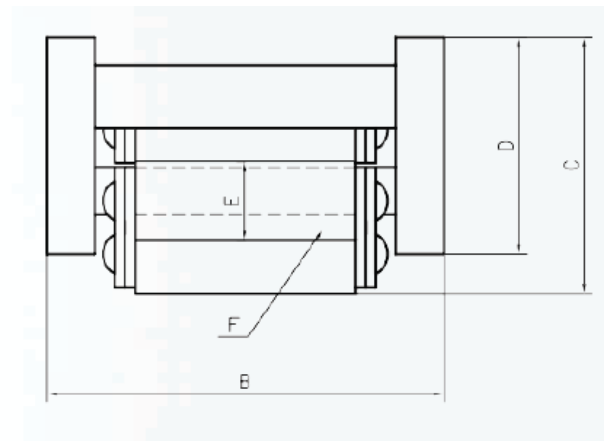
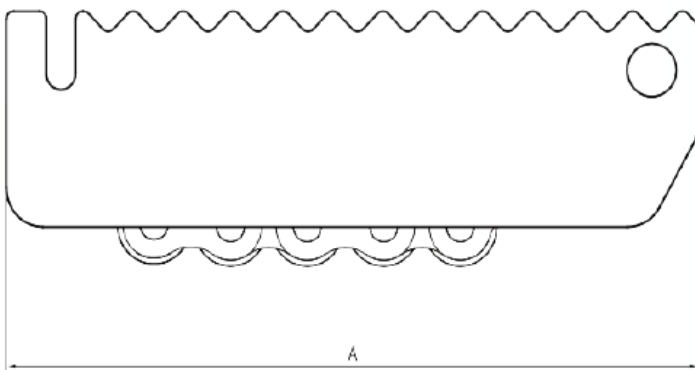

Sydney - Head Office

24 Foundry Road
Seven Hills, NSW 2147
Australia

+61 (0)2 8825 6900

+61 (0)2 8825 6999

Western Australia

8 Monash Gate
Jandakot, WA 6164
Australia

+61 (0)8 6253 1000

+61 (0)8 9458 9840

Auckland NZ

11 Druces Road
Wiri, Auckland 2104
New Zealand

+64 (0)9 263 5566

+64 (0)9 263 5567

